

INTRODUCTION GUIDE TO 3D RESISTIVITY IMAGING

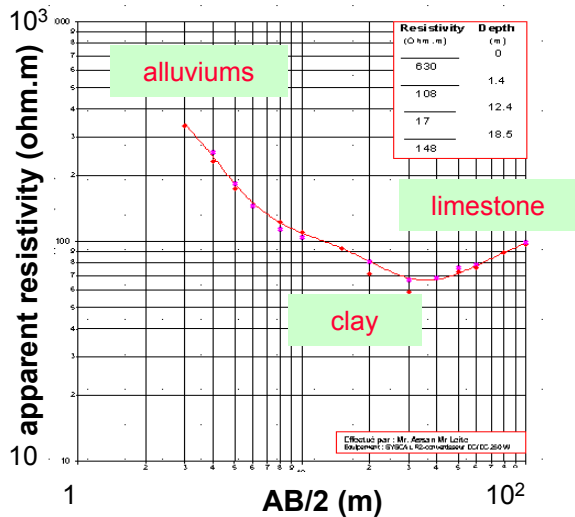

1D SOUNDING: Z

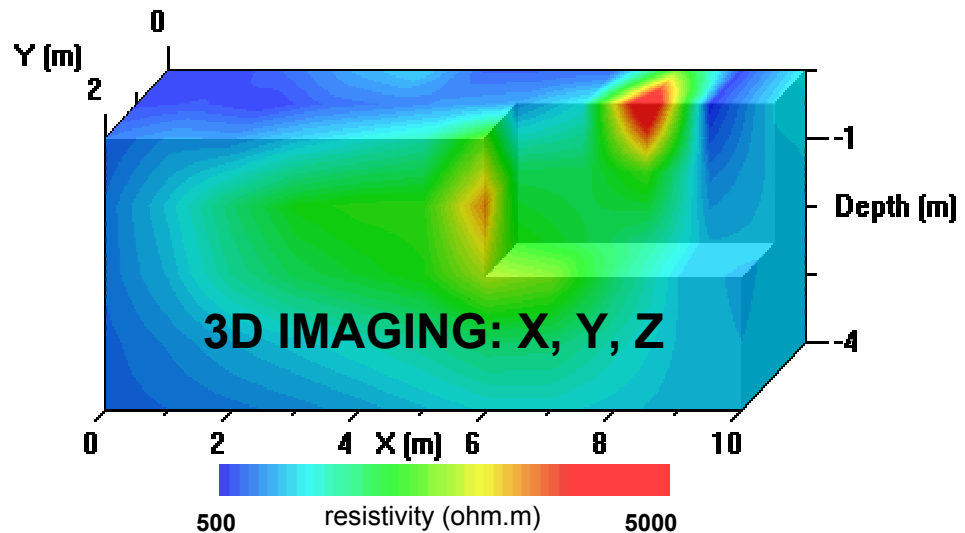
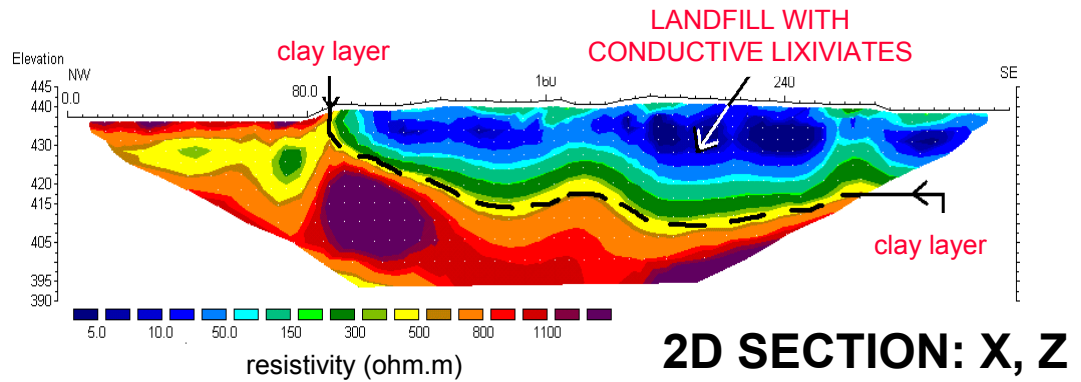

SURFACE AND HOLE 3D RESISTIVITY IMAGING

3D IMAGING FROM THE SURFACE

(with surface cables)

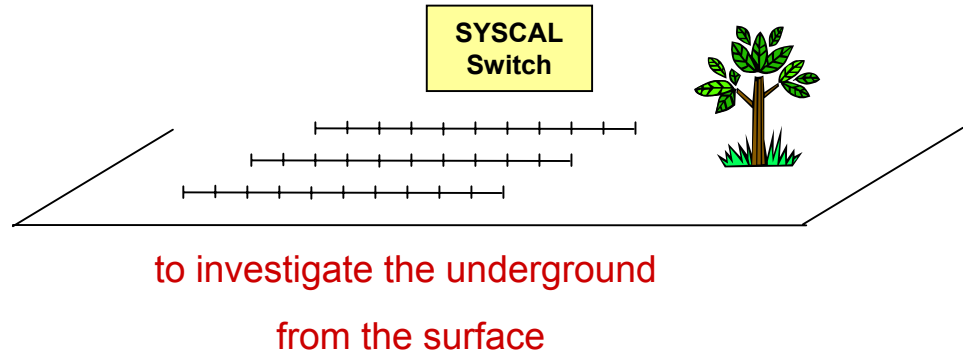
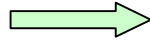

3D IMAGING BETWEEN TWO HOLES

(with borehole cables)

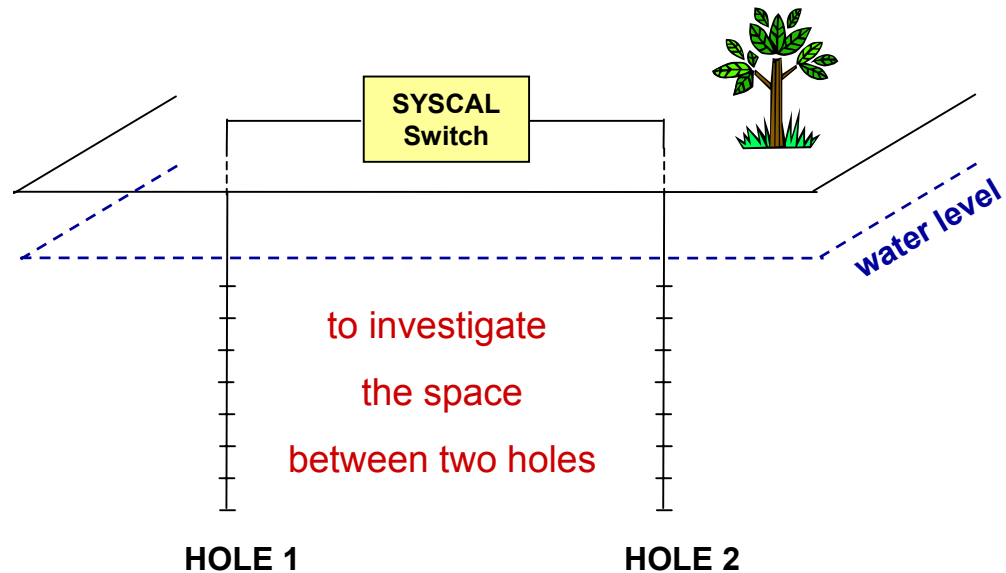

(the electrodes have to be placed under the water level)

Combinations of surface and borehole electrodes can also be used

SIMPLIFIED AND TRUE 3D RESISTIVITY IMAGING

1) SIMPLIFIED 3D IMAGING: 2D DATA ACQUISITION, 3D INVERSION

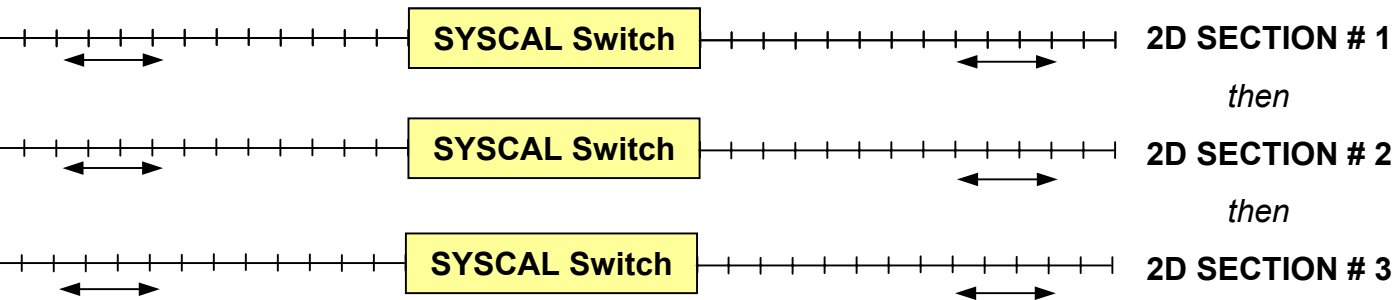

2) TRUE 3D IMAGING: 3D DATA ACQUISITION, 3D INVERSION

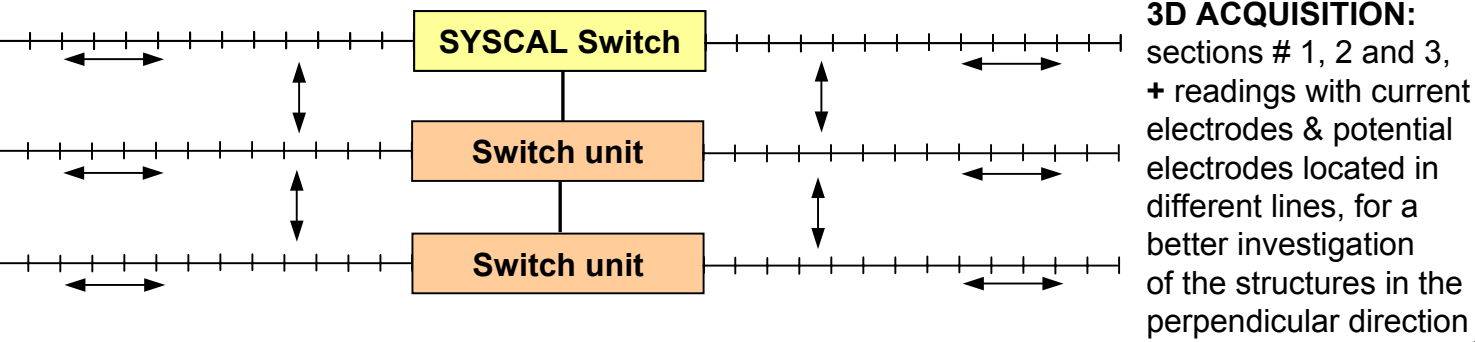



SYSCAL Switch = Transmitter + Receiver + Switch

Switch unit = Switch

3D
INVERSION
SOFTWARE
(Res3Dinv)

SKETCH OF A 3D RESISTIVITY IMAGING SURVEY with one « SYSCAL Switch » and three « Switch units »

« SQUARE TYPE » CONFIGURATION

-  SYSCAL Switch
-  Switch unit

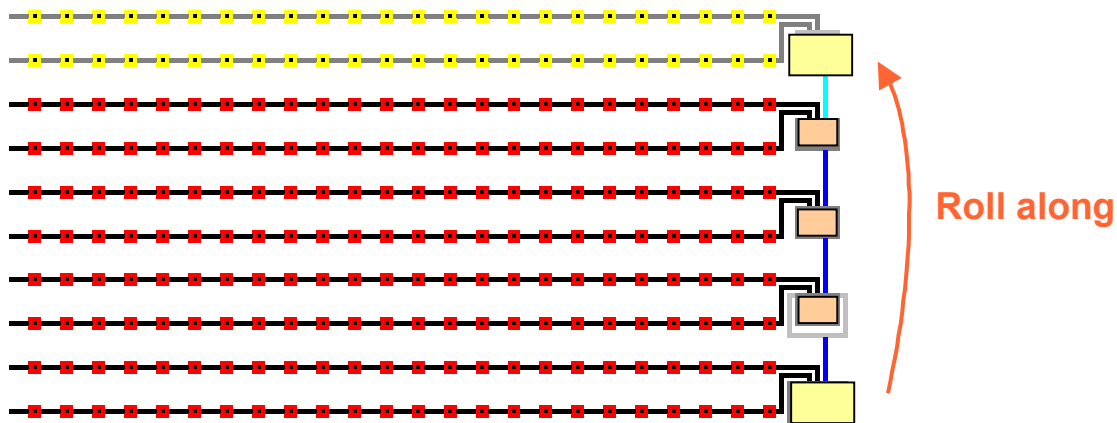

« RECTANGLE TYPE » CONFIGURATION

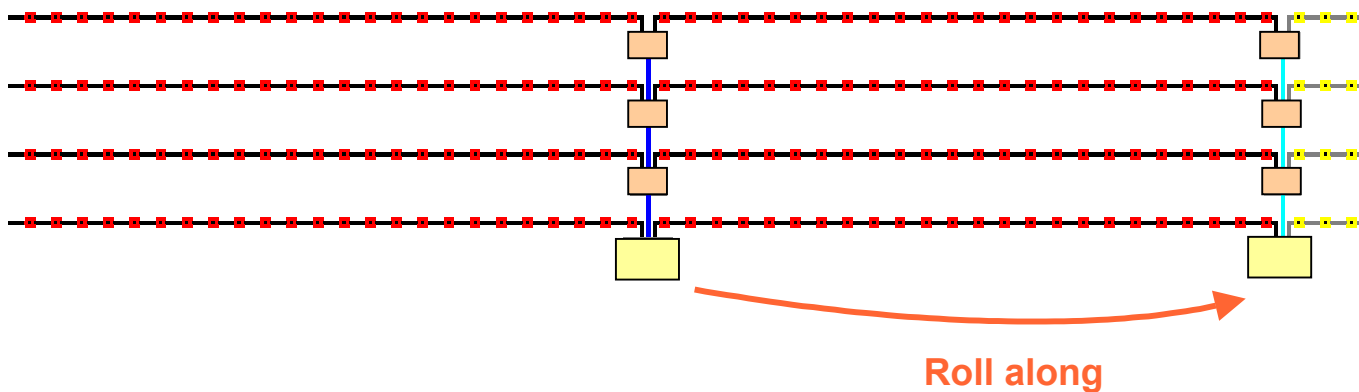

SKETCH OF A 3D RESISTIVITY IMAGING SURVEY with a « SYSCAL Switch » and 72 electrodes

2D CONFIGURATION FOR A ONE LINE SURVEY, WITH 72 ELECTRODES

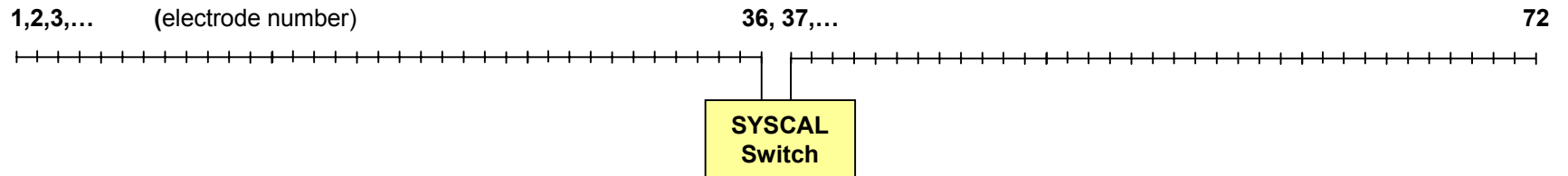

3D CONFIGURATION FOR A 6 LINE SURVEY, WITH 12 ELECTRODES / LINE

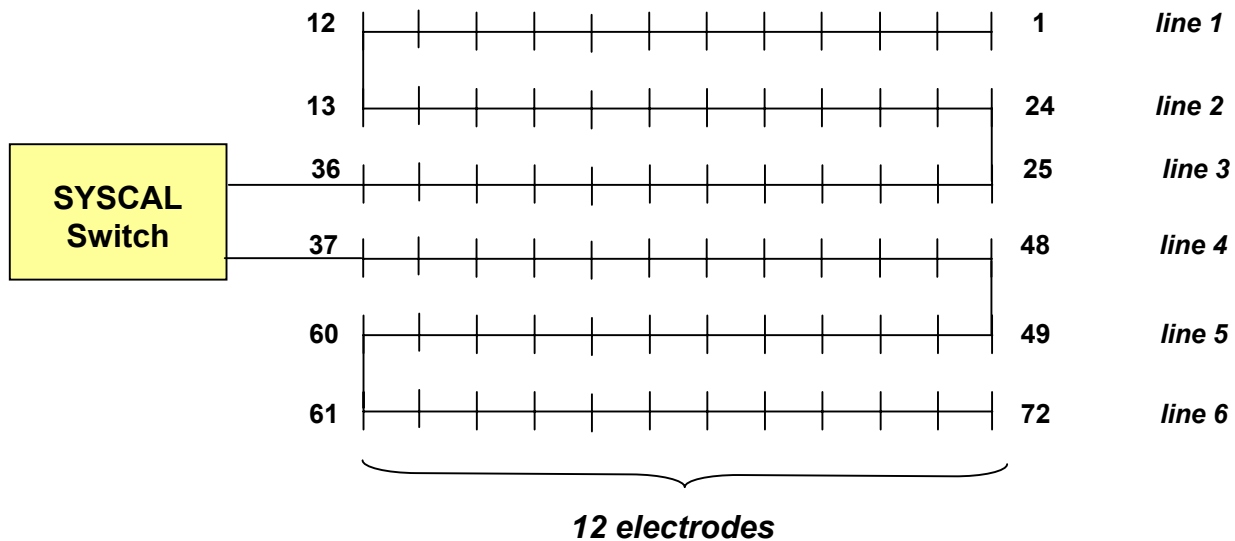

6 lines x 12 electrodes
=
72 ELECTRODES

CREATION OF 3D SEQUENCES FOR 72 ELECTRODES with ELECTRE III software

INTRODUCE THE ELECTRODE COORDINATES WITH THE AUTOMATIC NUMBERING PROCEDURE

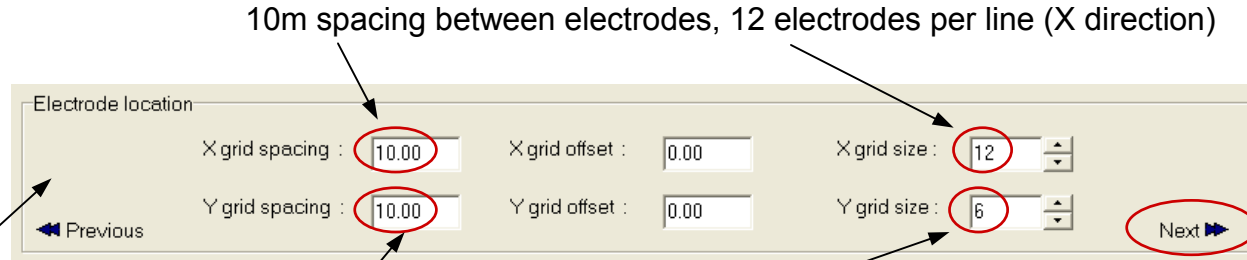
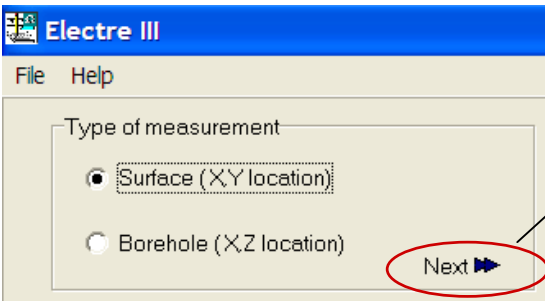

10m spacing between electrodes, 12 electrodes per line (X direction)

10m separation between lines, 6 lines, (Y direction)

Y \ X	0.00	10.00	20.00	30.00	40.00	50.00	60.00	70.00	80.00	90.00	100.00	110.00
0.00	12	11	10	9	8	7	6	5	4	3	2	1
10.00												
20.00												
30.00												
40.00												
50.00												

repeat the operation for all the other lines to number

Y \ X	0.00	10.00	20.00	30.00	40.00	50.00	60.00	70.00	80.00	90.00	100.00	110.00
0.00												
10.00												
20.00												
30.00												
40.00												
50.00												

click in case 1 and use "click and drag" to select the first line to number

Y \ X	0.00	10.00	20.00	30.00	40.00	50.00	60.00	70.00	80.00	90.00	100.00	110.00
0.00	12	11	10	9	8	7	6	5	4	3	2	1
10.00	13	14	15	16	17	18	19	20	21	22	23	24
20.00	36	35	34	33	32	31	30	29	28	27	26	25
30.00	37	38	39	40	41	42	43	44	45	46	47	48
40.00	60	59	58	57	56	55	54	53	52	51	50	49
50.00	61	62	63	64	65	66	67	68	69	70	71	72

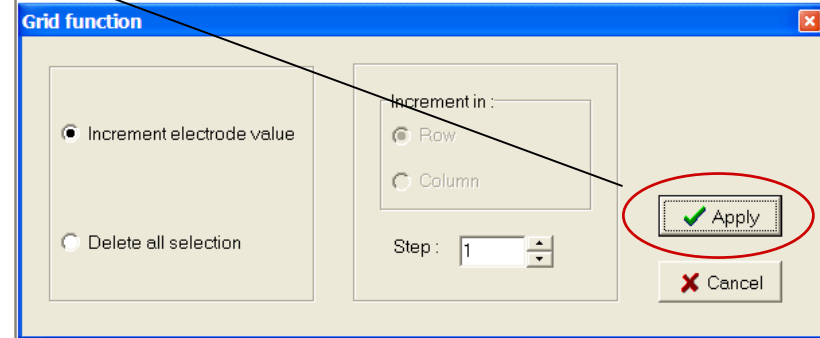

Next ► continue on next page

CREATION OF 3D SEQUENCES FOR 72 ELECTRODES

CHOOSE THE ELECTRODE ARRAY(S) FOR THE 3D RESISTIVITY IMAGING

3D = MANY ELECTRODES,
HIGH RESOLUTION REQUIRED

3D = ACQUISITION TIME
USUALLY < FIELD SET UP TIME
(ELECTRODES & CABLES, ...)



USE SEVERAL SEQUENCES
CORRESPONDING
TO VARIOUS ELECTRODE ARRAYS, SO AS
TO HELP THE INVERSION SOFTWARE,
IN THE DELINEATION OF THE STRUCTURES

Type of array :
Wenner-Schlumberger
complete pole-pole
cross-diagonal pole-pole
dipole-dipole
dipole-dipole equatorial
pole-dipole forward
pole-dipole reverse
Wenner
Wenner-Schlumberger
Schlumberger reciprocal

rank (1 : best)	penetration depth (in % of line length)	lateral resolution	signal amplitude	field set up (# of far electrodes)
1	Pole Pole (90%)	Dipole Dipole	Pole Pole	Wen Schlumb (0)
2	Pole Dipole (35%)	Pole Dipole	Wen Schlumb	Dipole Dipole (0)
3	Wen Schlumb (20%)	Wen Schlumb	Pole Dipole	Pole Dipole (1)
4	Dipole Dipole (20%)	Pole Pole	Dipole Dipole	Pole Pole (2)

with the **SYSCAL Pro SWITCH**
ELECTRE III optimizes the sequences
for enabling the SYSCAL to *simultaneously* measure
as many readings as possible,
for reducing the acquisition time
(for Wen and Wen Schlum, use the Schlum reciprocal)

ONCE AN ELECTRODE ARRAY HAS
BEEN SELECTED, THE PROGRAM
AUTOMATICALLY GENERATES A
SEQUENCE WHICH INCLUDES ALL
THE POSSIBLE COMBINATIONS OF
THIS ELECTRODE ARRAY,
IN THE X AND Y DIRECTIONS

DEFINITION OF MOST USUAL ELECTRODE ARRAYS

Dipole Dipole

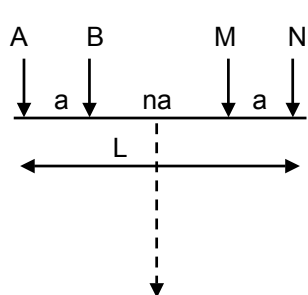

depth: **about $0.2 \times L$**

Wenner-Schlu

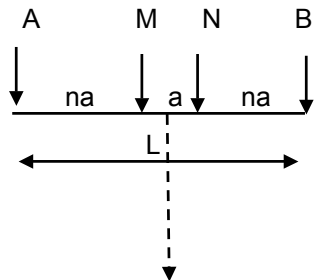

depth: **about $0.2 \times L$**

Schlum reciprocal

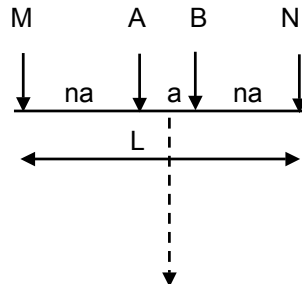

depth: **about $0.2 \times L$**

Pole Dipole

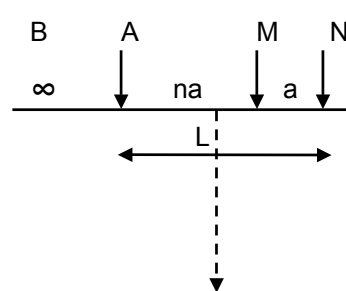

depth: **about $0.35 \times L$**

Pole Pole

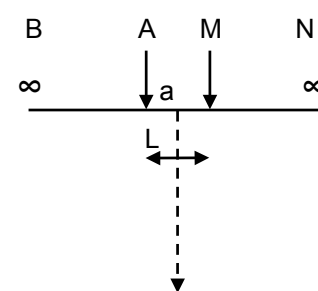

depth: **about $0.9 \times L$**

note: the electrode(s) at infinity must be placed at a distance of about 5 to 10 times the maximum line length of the array (L)

Type of array :
Wenner-Schlumberger
complete pole-pole
cross-diagonal pole-pole
dipole-dipole
dipole-dipole equatorial
pole-dipole forward
pole-dipole reverse
Wenner
Wenner-Schlumberger
Schlumberger reciprocal

rank (1 : best)	penetration depth (in % of line length)	lateral resolution	signal amplitude	field set up (# of far electrodes)
1	Pole Pole (90%)	Dipole Dipole	Pole Pole	Wen Schlumb (0)
2	Pole Dipole (35%)	Pole Dipole	Wen Schlumb	Dipole Dipole (0)
3	Wen Schlumb (20%)	Wen Schlumb	Pole Dipole	Pole Dipole (1)
4	Dipole Dipole (20%)	Pole Pole	Dipole Dipole	Pole Pole (2)

Equatorial Dipole Dipole

depth: **about $0.4 \times L$**

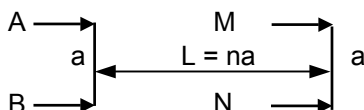

CREATION OF 3D SEQUENCES FOR 72 ELECTRODES

CREATE THE SEQUENCE OF READINGS WITH THE AUTOMATIC GENERATION PROCEDURE

select the electrode array

Type of array :

- dipole-dipole
- cross-diagonal pole-pole
- dipole-dipole**
- dipole-dipole equatorial
- pole-dipole forward
- pole-dipole reverse
- Wenner
- Wenner-Schlumberger
- Schlumberger reciprocal



select the levels for the spacing «a»

First spacing

Level : 1

Edit level

Depth level selection :

<input checked="" type="checkbox"/>	1	<input type="checkbox"/>	19
<input checked="" type="checkbox"/>	2	<input type="checkbox"/>	20
<input checked="" type="checkbox"/>	3	<input type="checkbox"/>	21
<input checked="" type="checkbox"/>	4	<input type="checkbox"/>	22
<input checked="" type="checkbox"/>	5	<input type="checkbox"/>	23
<input checked="" type="checkbox"/>	6	<input type="checkbox"/>	24
<input checked="" type="checkbox"/>	7	<input type="checkbox"/>	25
<input checked="" type="checkbox"/>	8	<input type="checkbox"/>	26
<input type="checkbox"/>	9	<input type="checkbox"/>	27
<input type="checkbox"/>	10	<input type="checkbox"/>	
<input type="checkbox"/>	11	<input type="checkbox"/>	
<input type="checkbox"/>	12	<input type="checkbox"/>	

OK

select the levels for the spacing «2a»

Second spacing

2 x spacing

Level : 0

Edit level

Depth level selection :

<input type="checkbox"/>	1/2	<input type="checkbox"/>	19/2
<input type="checkbox"/>	1	<input checked="" type="checkbox"/>	10
<input type="checkbox"/>	3/2	<input type="checkbox"/>	21/2
<input type="checkbox"/>	2	<input checked="" type="checkbox"/>	11
<input type="checkbox"/>	5/2	<input type="checkbox"/>	23/2
<input type="checkbox"/>	3	<input checked="" type="checkbox"/>	12
<input type="checkbox"/>	7/2	<input type="checkbox"/>	25/2
<input type="checkbox"/>	4	<input checked="" type="checkbox"/>	13
<input type="checkbox"/>	9/2	<input type="checkbox"/>	27/2
<input type="checkbox"/>	5	<input checked="" type="checkbox"/>	14
<input type="checkbox"/>	11/2	<input type="checkbox"/>	29/2
<input type="checkbox"/>	6	<input checked="" type="checkbox"/>	15
<input type="checkbox"/>	13/2	<input type="checkbox"/>	31/2
<input type="checkbox"/>	7	<input type="checkbox"/>	16
<input type="checkbox"/>	15/2	<input type="checkbox"/>	
<input checked="" type="checkbox"/>	8	<input type="checkbox"/>	
<input type="checkbox"/>	17/2	<input type="checkbox"/>	
<input checked="" type="checkbox"/>	9	<input type="checkbox"/>	

OK

select the levels for the spacing «3a»

Third spacing

3 x spacing

Level : 0

Edit level

Depth level selection :

<input type="checkbox"/>	37/3	<input type="checkbox"/>	55/3
<input type="checkbox"/>	38/3	<input checked="" type="checkbox"/>	56/3
<input type="checkbox"/>	13	<input type="checkbox"/>	19
<input type="checkbox"/>	40/3	<input type="checkbox"/>	58/3
<input type="checkbox"/>	41/3	<input type="checkbox"/>	59/3
<input type="checkbox"/>	14	<input checked="" type="checkbox"/>	20
<input type="checkbox"/>	43/3	<input type="checkbox"/>	61/3
<input type="checkbox"/>	44/3	<input type="checkbox"/>	62/3
<input checked="" type="checkbox"/>	15	<input checked="" type="checkbox"/>	21
<input type="checkbox"/>	46/3	<input type="checkbox"/>	64/3
<input type="checkbox"/>	47/3	<input type="checkbox"/>	
<input checked="" type="checkbox"/>	16	<input type="checkbox"/>	
<input type="checkbox"/>	49/3	<input type="checkbox"/>	
<input type="checkbox"/>	50/3	<input type="checkbox"/>	
<input checked="" type="checkbox"/>	17	<input type="checkbox"/>	
<input type="checkbox"/>	52/3	<input type="checkbox"/>	
<input type="checkbox"/>	53/3	<input type="checkbox"/>	
<input checked="" type="checkbox"/>	18	<input type="checkbox"/>	

OK

select the number of channels measured simultaneously (1 for SYSCAL Jr, R1+, R2, 10 for SYSCAL Pro)

Multi-channel optimization

Nb channel : 1

Multi-channel optimization

Nb channel : 10

Compute

Computed

Original sequence statistics

Quad. number : 336

Number of injection : 90

Number of channel(s) used : 8

Optimized sequence statistics

Quad. number : 336

Number of injection : 90

Number of channels finally used : 8

Optimization gain : 1

OK

Cancel

computation of the sequence

Enregistrer sous

Enregistrer dans : Electre III

Comment.Txt
DD.txt
DDe.txt

give a name to the file which will include the sequence just defined («txt» format)

Nom du fichier : DDee

Type : Text file (*.txt)

Save as

C:\Program Files\IRIS Instruments\Electre III\DDee.txt

Save in file

Electrode coordinate

Quadrupole array

Separator

Comma

Space

Tabulation

OK

Cancel

then, with ELECTRE II:

- press OPEN button to open the «txt» file
- save it as a «sqx» file (file menu),
- transfer it into the SYSCAL memory

FIELD DATA ACQUISITION WITH SYSCAL Switch

FIELD SET UP:

- dig the electrodes and connect them to the cables; connect the SYSCAL Switch to the cables
- select the **sequence** to apply
- check the batteries
- check the electrode ground resistance
- control **the quality** of the future readings by fixing the “stack min”, “stack max”, and “quality factor” (standard deviation) parameters
- run the selected sequence

ACQUISITION TIME FOR A SEQUENCE OF 1000 READINGS	RESISTIVITY (5 stacks, 0.5s ON time)	RESISTIVITY & IP (15 stacks, 2s ON & OFF times)
SYSCAL R1 Plus Switch (1 channel measurement)	1 hour	12 hours
SYSCAL Pro Switch (10 channel measurement)	8 minutes	1 hour ½



SYSCAL R1 Plus Switch, 24, 48, 72
600V, 200W, 2.5A



10 simultaneous channel equipment

SYSCAL Pro Switch, 48, 72, 96
800V, 250W, 2.5A



SWITCH Pro unit
(48, 72, 96 extension)

PROCESSING 3D DATA WITH PROSYS II SOFTWARE

DATA TRANSFER TO PC

- **Connect serial or USB link** (SYSCAL to PC)
- **Run PROSYS II** software: communication, data download, SYSCAL type, & follow PC indications
- **Give a name** to the new global file data (.bin file)

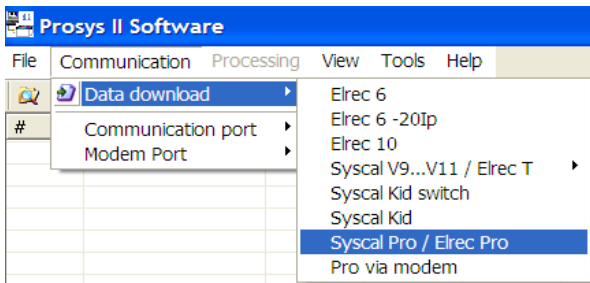

MODIFY SPACING

If the spacing (like the line number Y of a profile) has to be changed, go to **“file / processing / modify spacing”** and key in the proper value (Y) for the A, B, M, N electrodes (spacings 5, 6, 7, 8) of all the readings of this file

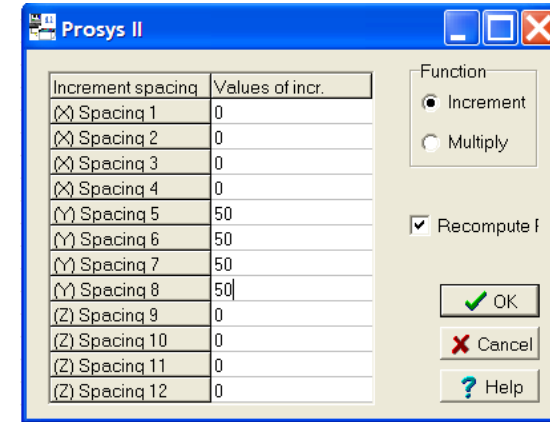

MERGING FILES

When various data files successively acquired on the same site and have to be interpreted together, they have first to be merged with the PROSYS II software: **Open** “file 1”, **Add** “file 2”, **Add** “file 3”, **Save as**, and give a name to the file which will include all the data (“file 123”)

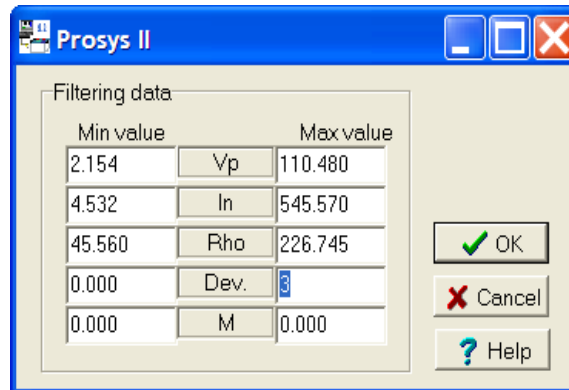
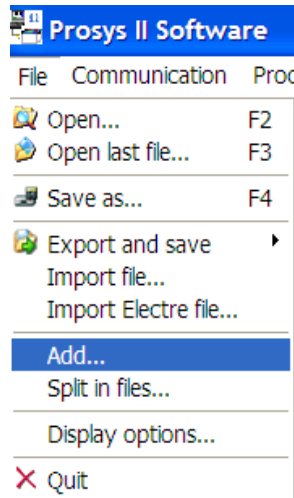

FILTERING THE DATA

By using the **“processing / filtering”** function, it is possible to devalidate the noisy readings for which the standard deviation is greater than a given value (3% for example).

EXPORT TO RES3Dinv

Once the «.bin» data file has been processed with PROSYS II, export them towards RES3dinv, and give a name to this new file («.dat» file)

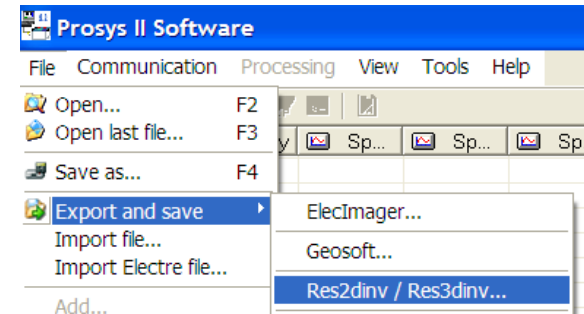

INTERPRETING 3D DATA WITH RES3Dinv SOFTWARE

BASIC OPERATING PROCEDURE OF THE RES3Dinv SOFTWARE

RES3Dinv MAIN MENU

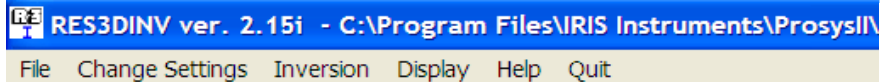

HOW TO INVERT THE DATA ?

Introduce the data file (.dat) : “file / read data file”, OK

Run the inversion: “inversion / least square inversion”

Display the results: “display / display results / display inversion model”

Select the type of display: “sections” (horizontal sections, at various depths) or “slices” (vertical slices, along various lines): *see examples on the next two slides*

CHANGE THE COLOUR SCALE

- click on “display / show inversion results”, then on «display sections / display data and model sections”
- modify the **scale of the colours** (the resistivity limits for the 16 colours, or the colours themselves)
- store the new colour scale with the “file / store colour scale” function

EXPORT TO 3D VISUALIZATION PROGRAMS

Use the function “**file / export**” to make the RES3Dinv inversion result file compatible with the following 3D visualization software programs:

-Slicer Dicer

- Rockware

These programs visualize the inversion model in 3D, for a better understanding of the volumes of the various structures detected

see an example on third next slide

INTERPRETING 3D DATA WITH RES3Dinv SOFTWARE

REPRESENTATION OF THE RESULTS IN HORIZONTAL SECTIONS AT VARIOUS DEPTHS

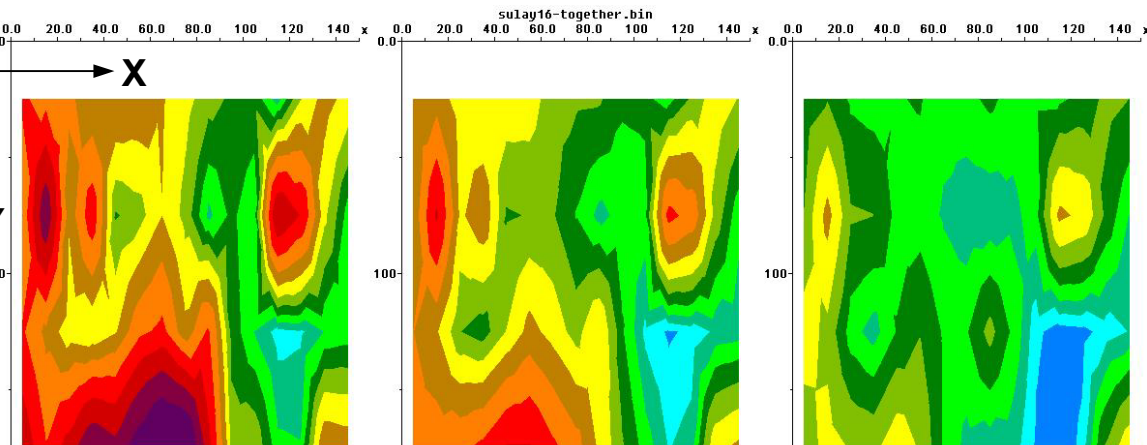

0-5m depth

5-10m depth

10-17m depth

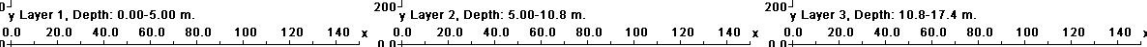

17-25m depth

25-34m depth

34-43m depth

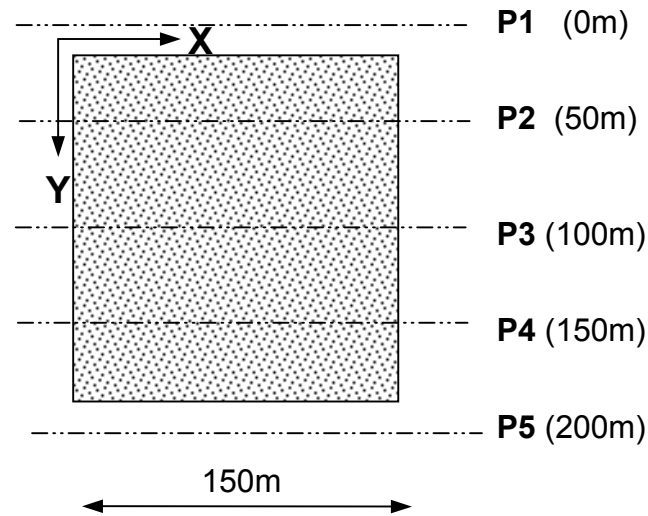
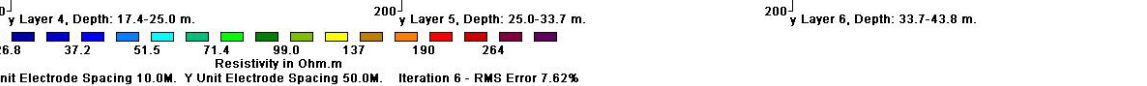

5 PROFILES (P1 to P5)
with 16 electrodes at 10m spacing,
Wenner Schlumberger array

INTERPRETING 3D DATA WITH RES3Dinv SOFTWARE

REPRESENTATION OF THE RESULTS IN VERTICAL SLICES, ALONG VARIOUS LINES

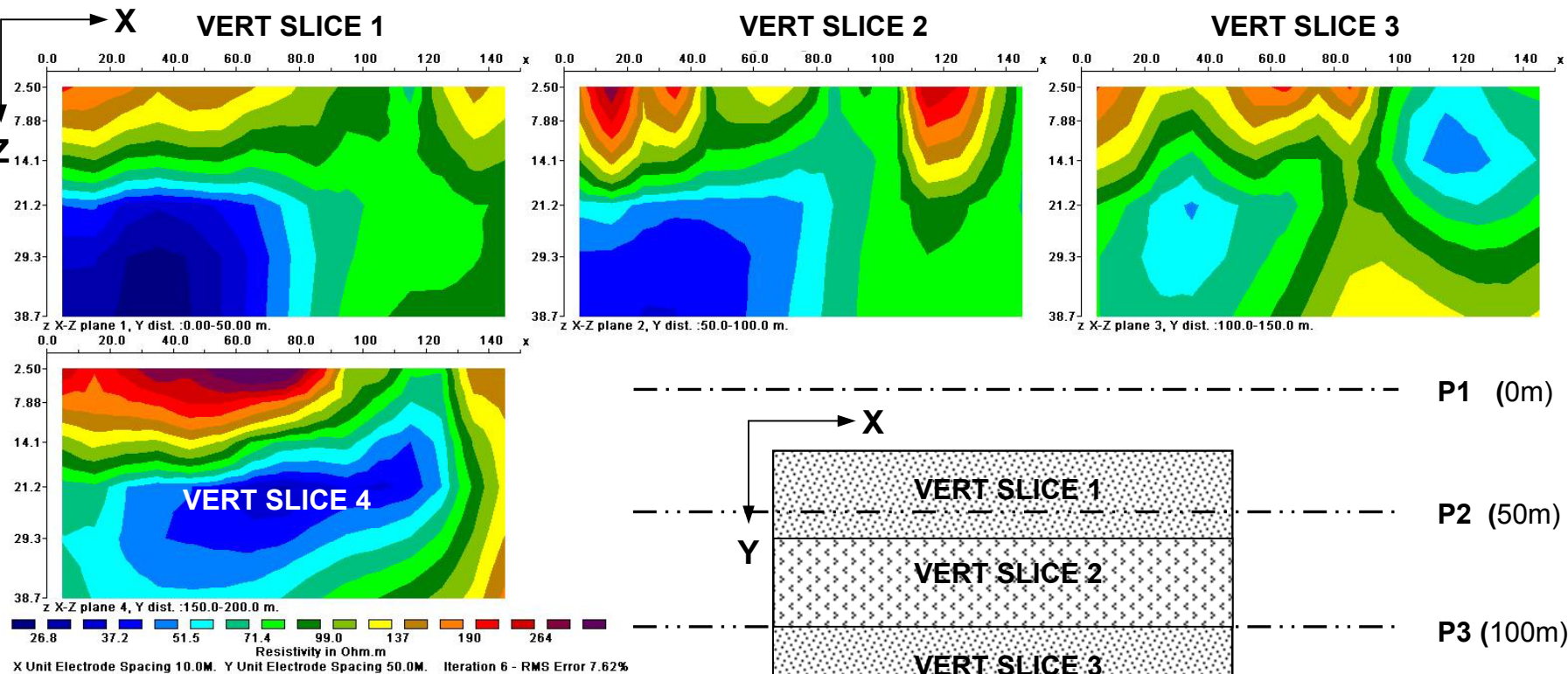

5 PROFILES (P1 to P5)
 with 16 electrodes at 10m spacing,
 Wenner Schlumberger array



PLOTTING 3D VOLUMES WITH SLICER / DICER PROGRAM

REPRESENTATION OF THE INVERSION RESULTS IN VOLUMES

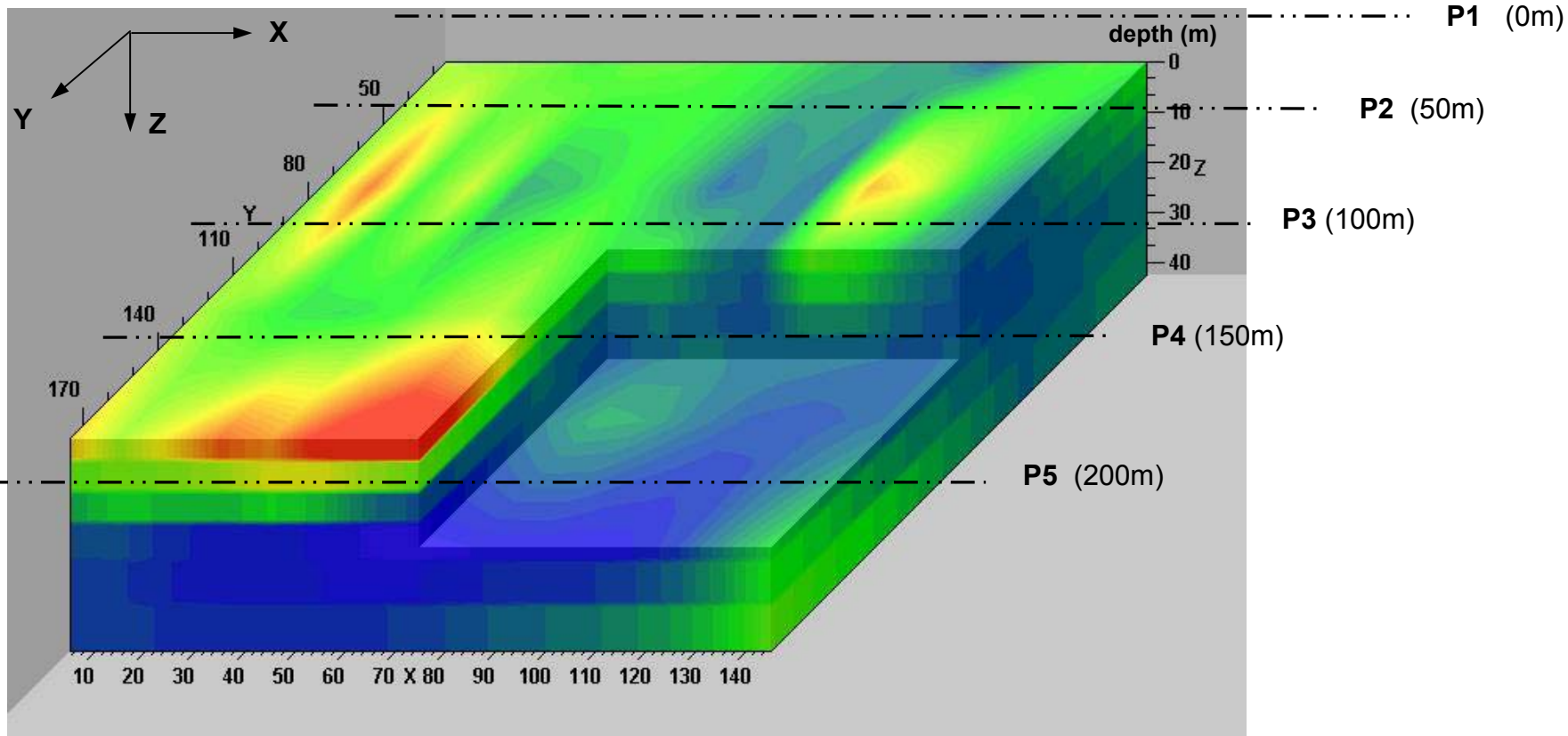

RESISTIVITY values, in ohm.m

5 PROFILES (P1 to P5)
with 16 electrodes at 10m spacing,
Wenner Schlumberger array